

Homework

Marrying functionality, simplicity and contemporary design aesthetics, Homework embraces the compound nature of its name by challenging the relevance of clear-cut workspaces and bringing a feeling of home to work. The collection features upholstered elements with natural details and can be customised so as to mould and adapt to both home and office settings or simply a change of mind.





Homework

Information

Design

Alexander Lotersztain, 2016

Environment

Indoor

Warranty

5 year structural

Certifications

GECA certified

Materials

Dunlop Enduro® foam with MDF substrate, upholstered in Customer's Own Material (COM) and/or Leather (COL). Legs in solid timber. All table tops constructed of veneered MDF. Occasional table base constructed in powder coated mild steel.

Notes

- Each seating unit supplied with linking plate, used to connect units together.
- Underseat power unit available for all seating.
- Table top power integration available for workstations & workbooths.

Finishes

Upholstery



Fabric
COM



Leather
COL

Legs



American Oak



Black Stained
American Oak



American Walnut

Table Tops



American Oak
Veneer



Black Stained
Veneer



American Walnut
Veneer

Occasional Table Base



White
Powder Coat



Black
Powder Coat

Dimensions

Single Seater

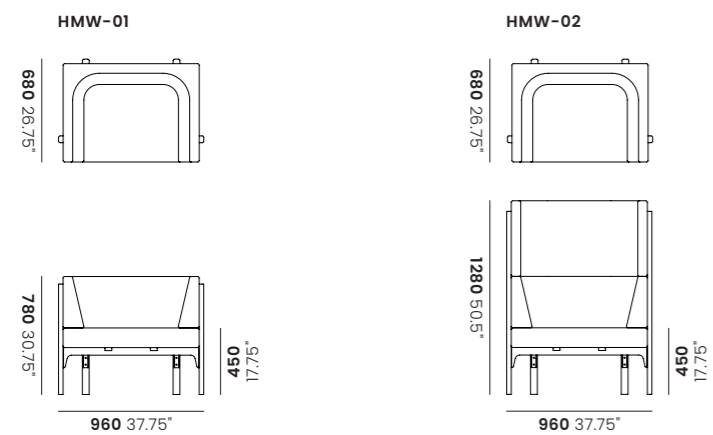

Double Seater

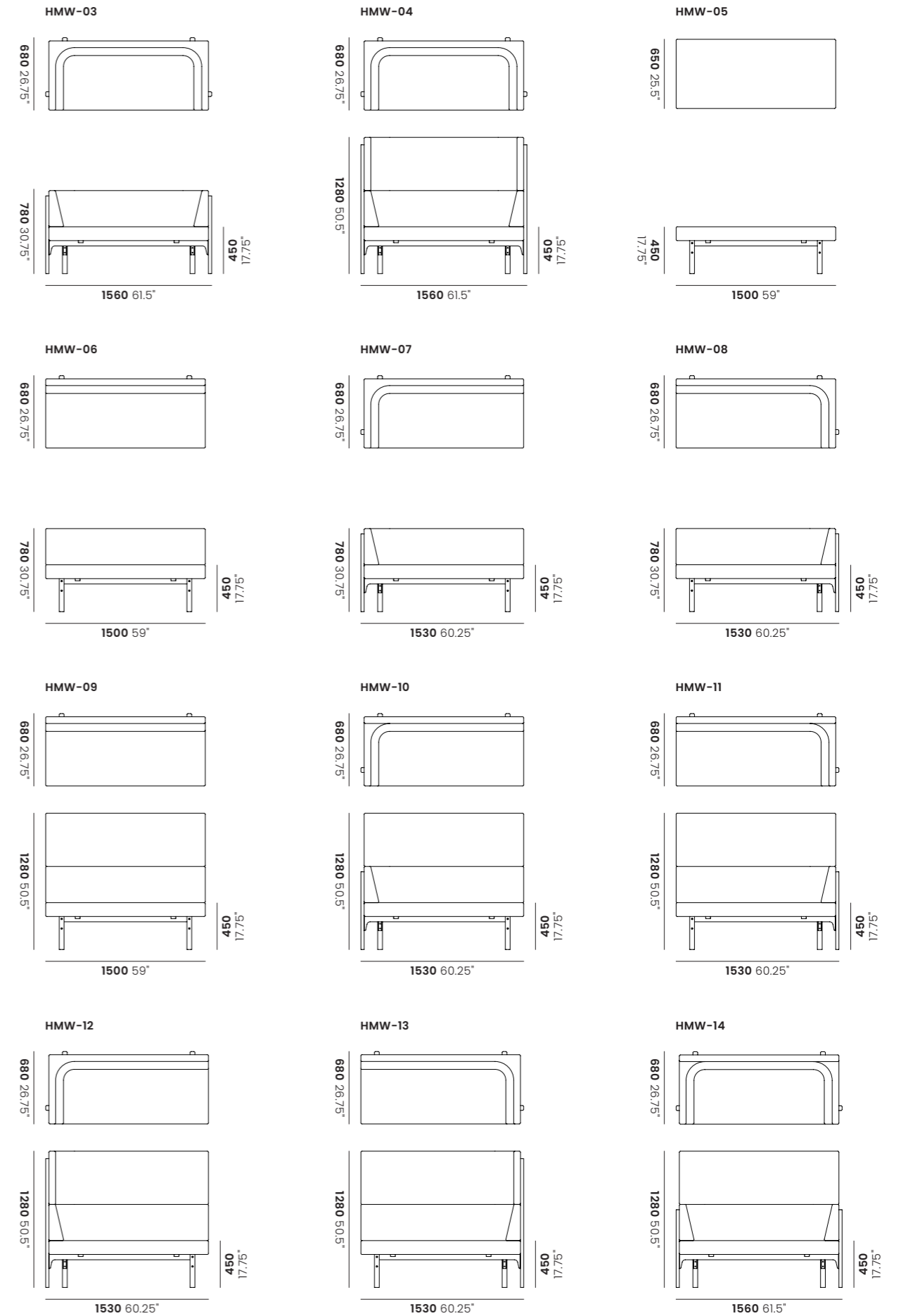

Double Seaters (Continued)

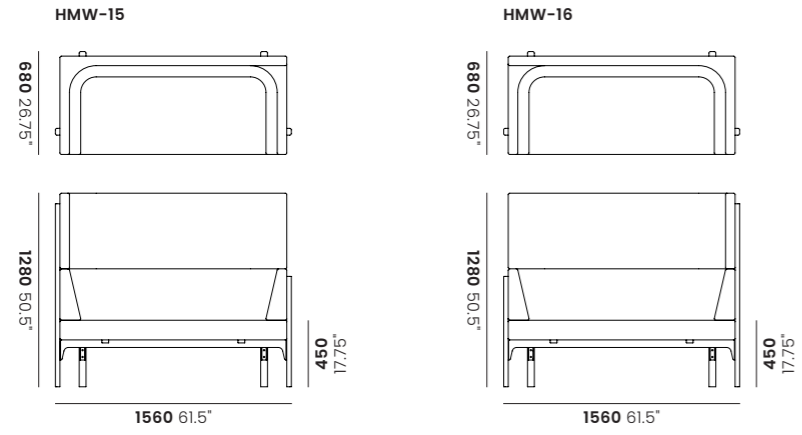

60° Angled Seating

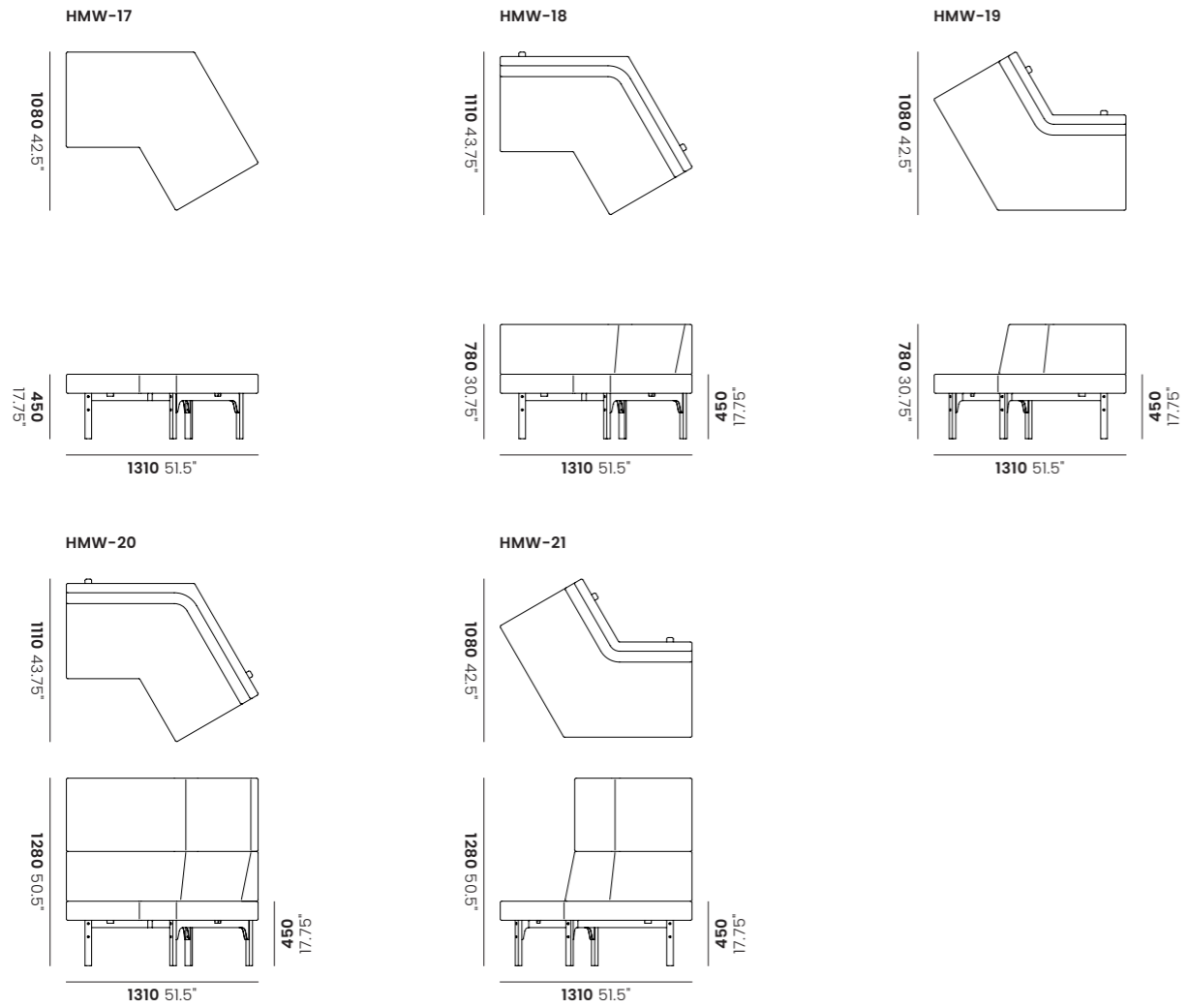

90° Curved Seating

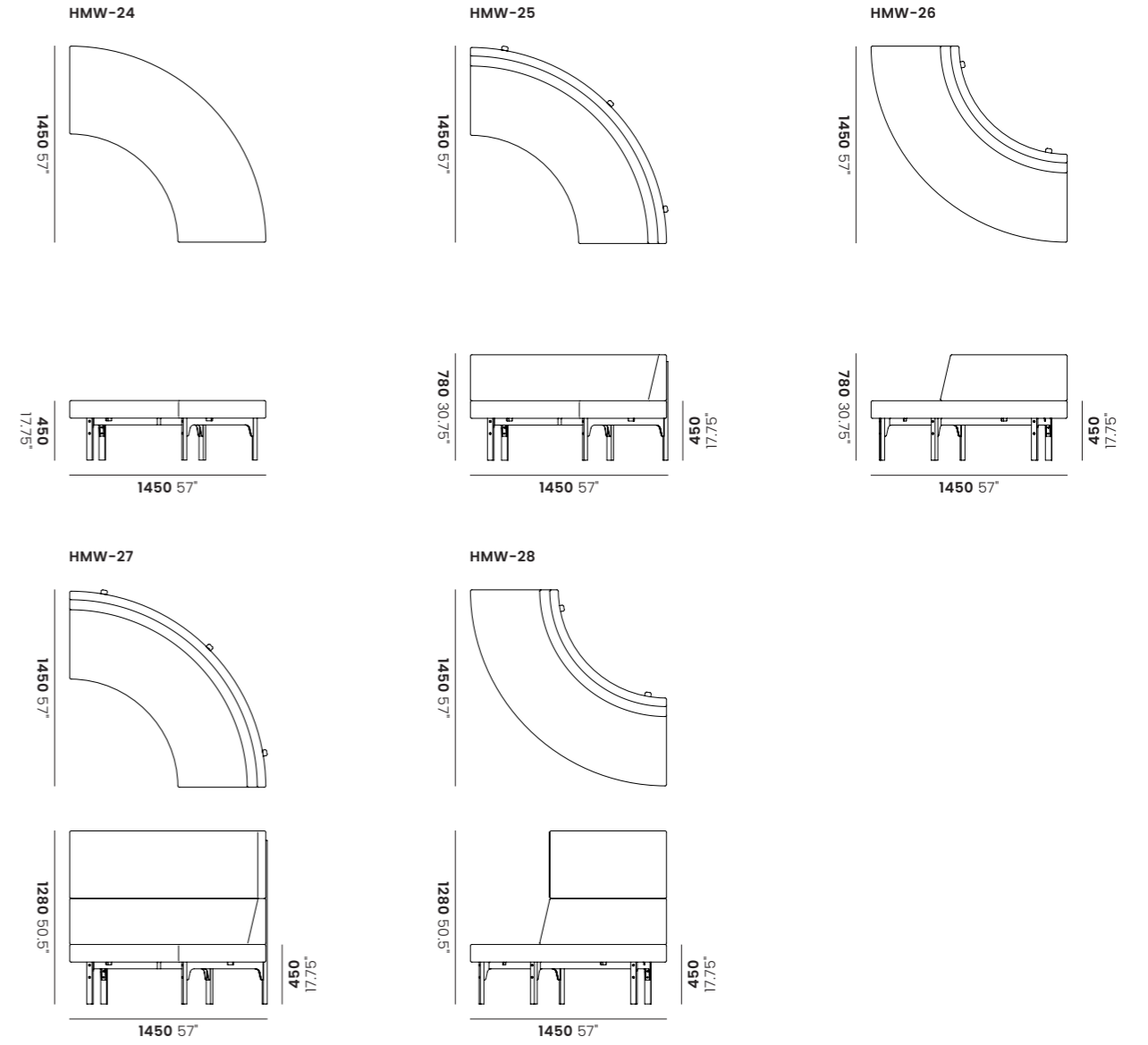

Side Tables

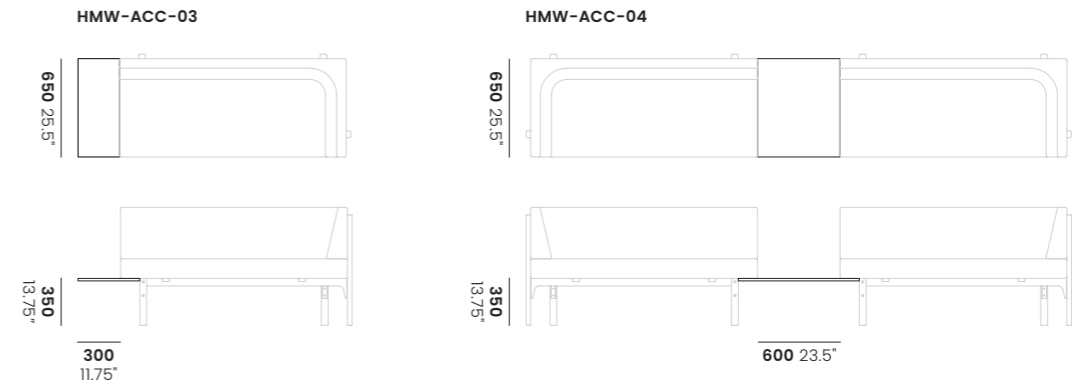

Back Tables

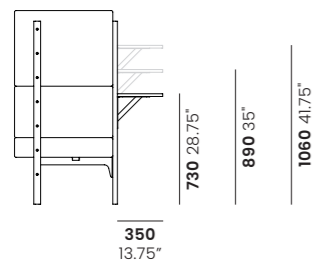

HMW-ACC-05

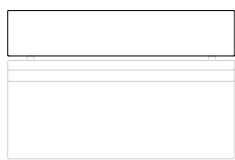

HMW-ACC-06

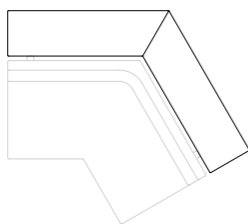

HMW-ACC-07

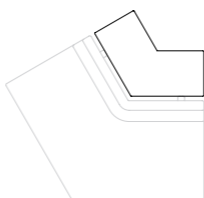

HMW-ACC-08

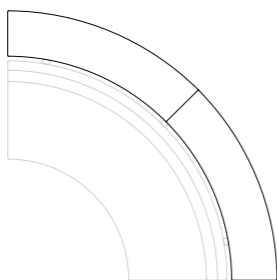

HMW-ACC-09

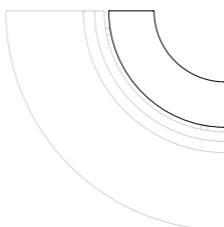

Workstations

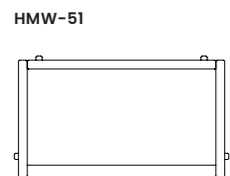

HMW-81

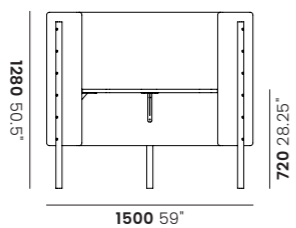
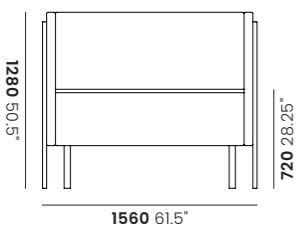
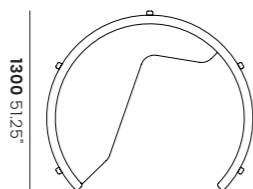

4 Person Workbooths

HMW-61

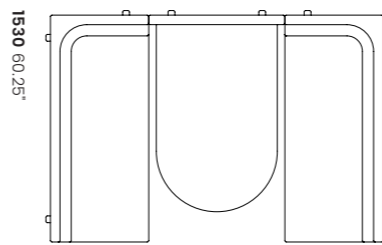

HMW-62

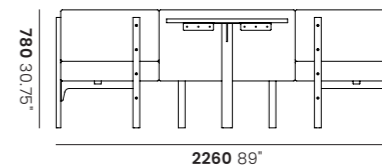
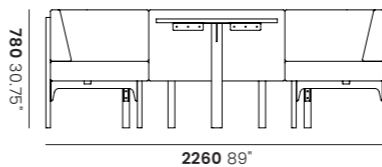
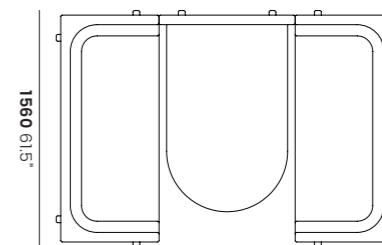

HMW-63

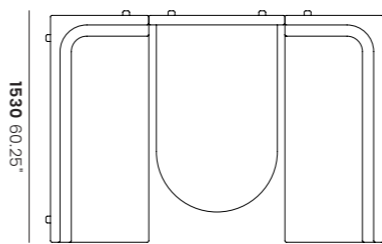

HMW-64

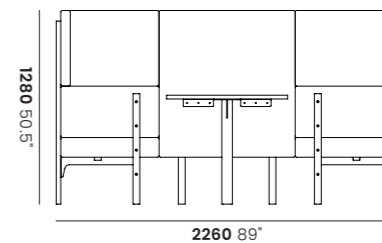
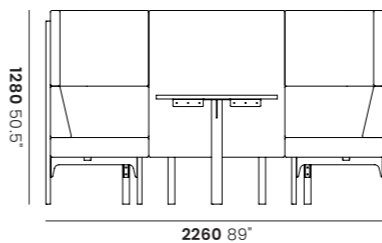
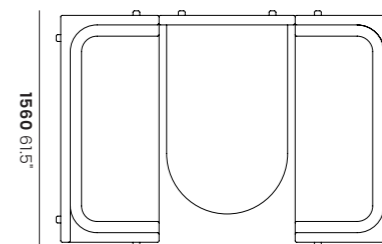

HMW-65

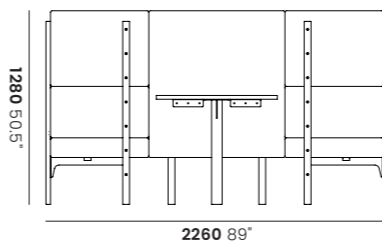
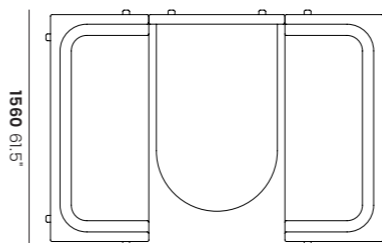

Occasional Table

HMW-101

